

# Syntax

## Functional Categories above vP: TP

Modul 04-006-2002  
Phonology – Morphology – Syntax

Institut für Linguistik

Universität Leipzig

[home.uni-leipzig.de/heck](http://home.uni-leipzig.de/heck)

# Recap

## *Recap Ditransitives etc.:*

- C-command tests (illustrated by means of reflexivization, but other diagnostics suggest the same) point to the conclusion that ditransitive constructions (in English) are binary right-branching (similar arguments may carry over to other languages as well).
- Word order requirements suggest that the EA (bearing the agent-role) is generated in the specifier of a projection outside VP, called vP, the head of which assigns the agent role to the EA.
- The lexical verb is merged within VP and then *moves* to v. Movement is just another instance of the operation Merge, with the particular property that one of the elements being merged is taken from inside the other element (internal Merge).
- Unergative and unaccusative predicates can now be distinguished structurally: the latter have an EA (merged in Specv), the former an IA (merged as the complement of V). The v-head present in unaccusative structures does not assign a theta-role (or is not present at all).

# Outlook

## *Outlook:*

- So far, *v* is the head of a clause. In what follows, arguments will be given that the clause structure (at least in English) involves another functional projection above *vP* headed by the category *T*: *TP*.
- The resulting structure (of a transitive clause) will look as in (1) (ignoring possible movement operations for now).

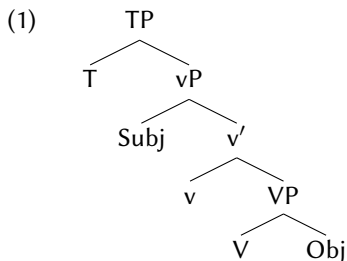

# Modals

*Observation:*

*Modal verbs* (such as *may*, *must*, *can*, etc., in English) embed other predicates (e.g. VPs such as *seek Ishtar*).

- (2) a. Gilgamesh *may* seek Ishtar.
- b. Gilgamesh *must* seek Ishtar.
- c. Gilgamesh *can* seek Ishtar.
- d. Gilgamesh *should* seek Ishtar.
- e. Gilgamesh *will* seek Ishtar.

*Note:*

- *Gilgamesh* in (2-a-e) realizes the agent-role of the causative *v* by being merged in *Specv*.
- VP-fronting (3) suggests that the main verb (together with *v*, recall that *V* moves to *v*) forms a constituent together with the IA to the exclusion of the modal (and the EA).

(3) *Gilgamesh* said that he may *seek Ishtar* ...  
... and [ *seek Ishtar* ], *Gilgamesh* may \_.



# Modals

## Consequence:

- VP-fronting must have affected the whole vP (or, perhaps, v', see below): V+v form a complex after head movement. I.e., what is traditionally called VP-fronting is actually vP-fronting. (But note that we will stick to the notion of VP-fronting for expository reasons.)
- Since the modal (and the EA) remains unaffected by VP-fronting, see (3), it must be merged outside vP, see (4).

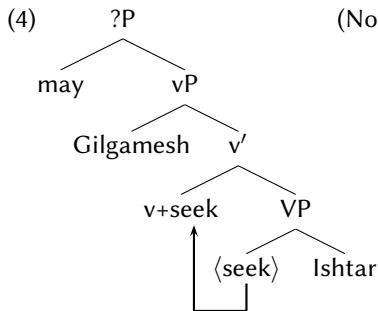

(Note: v+seek is a shorthand for a structure where the verb has adjoined to v.)

# Modals

*Two problems:*

- (4) is incompatible with the word order *Gilgamesh may seek Ishtar*, where the modal shows up in between the EA and the main verb.
- If what undergoes fronting in (3) is vP, then, provided (4), it is surprising that *Gilgamesh* does not undergo fronting, too.

*Note:*

- The second problem could be solved by assuming that VP-fronting actually targets the v'-node in (4). In what follows, this will be excluded by adopting, without further argument, the often assumed dogma in (5). (Why (5) should hold is an open question.)
- The first problem remains in any event.

(5) *Ban on affecting intermediate projections:*  
X'-categories cannot be affected by syntactic operations (in particular movement).

# Moving the EA

*General solution:*

- Both problems vanish if the EA moves and becomes the specifier of a higher head (an instance of *phrasal movement*). Then it precedes the modal, and subsequent VP-fronting (vP-fronting) will not affect it.
- Assumption: The EA is merged in Specv (realizing the agent-role) and then moves to the specifier of the head realized by the modal (6).

(6)

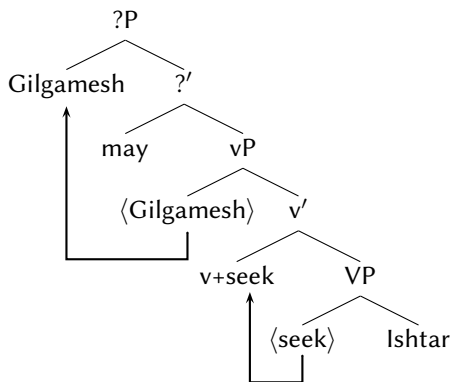



# Merge-position of the EA

## Question:

Couldn't one instead a) merge the EA in the specifier of the modal to begin with (7-a), or b) analyze the modal as being an instance of v (7-b)? Both analyses would do without postulating any movement of the EA.

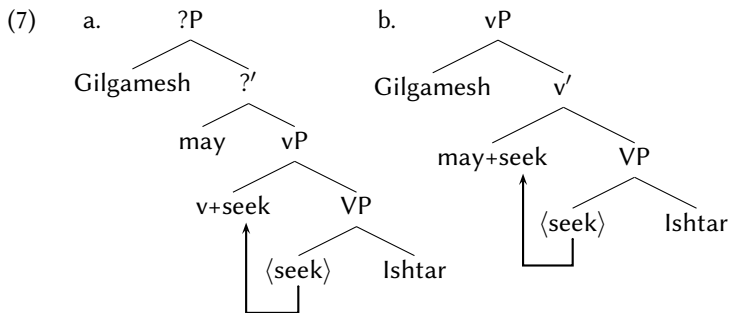

## Arguments:

In what follows, arguments in favor of merging the EA vP-internally (and against the alternatives above) are given (see also Grewendorf 2002, Adger 2003).

# Merge-position of the EA

## *Argument against (7-b):*

- Since VP-fronting must be able to affect the main verb to the exclusion of the modal (recall (3)), (7-b) would require to assume that there is no V-to-v movement if v = modal.
- But this assumption is not compatible with the syntax of ditransitives, which requires such verb movement to take place, even in the context of a modal (8-a,b); also cf. (9).

- (8) a. Dr. Brumm may give [<sub>VP</sub> Pottwal the honey ].  
b. \*Dr. Brumm may [<sub>VP</sub> Pottwal give the honey ].

- (9) Dr. Brumm said that he may give Pottwal the honey ...  
... and [ give Pottwal the honey ], he will \_.



# Merge-position of the EA

*First argument against (7-a):*

- The first argument is theory-internal. It seems clear that *Gilgamesh* in (7-a) receives its agent-role from *seek* (more precisely: from the v-head associated with the lexical verb), and not from the modal.
- If one merges *Gilgamesh* in Spec? directly, then  $\Theta$ -role assignment cannot be local. But we assumed that it must be local because each  $\Theta$ -role is associated with a [uF], and [uF]s must be checked under sisterhood.

# Merge-position of the EA

## *Second argument against (7-a):*

- The paraphrase of (10-a) in (10-b) suggests that the modal operator (“it is possible”) has logical scope over the proposition comprising the EA *Gilgamesh*.
- This is reflected by the representation in (6), assuming that logical scope translates into c-command: in (6), *may* c-commands the position where the EA is merged.
- In contrast, it is not reflected by (7-a): here the modal does not c-command the EA.

- (10)    a.    Gilgamesh may seek Ishtar.  
          b.    It is possible that Gilgamesh seeks Ishtar.

# Merge-position of the EA

*Third argument against (7-a):*

- Some quantifying elements semantically associated with the EA, such as *all* in English, can either show up together with the EA (suggesting constituency of quantifier and EA), see (11-a), or dissociated from the EA, below it (11-b) (see Sportiche 1988 on French).
- (11-b) may be analyzed as involving movement of only part (*the friends*) of the EA *all the friends*, leaving the associated quantifier *all* behind in Specv (“stranding”), see (12-b).

- (11) a. *All the friends* may leave.  
b. *The friends* may *all* leave.

# Merge-position of the EA

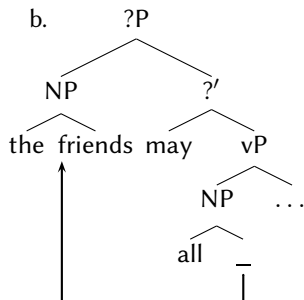
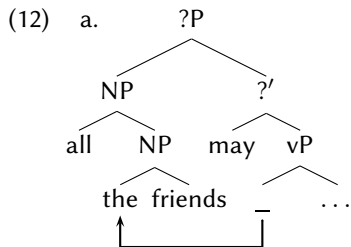

# Merge-position of the EA

Fourth argument against (7-a):

- Reciprocals (like *each other*) require a c-commanding antecedent (just like reflexives do).
- (13-a) involves fronting of a PP (containing a reciprocal). As the coindexations indicate, the reciprocal *each other* can have both the EA *they* of the embedding clause and the EA *we* of the embedded clause as a possible antecedent.
- In contrast, (13-b), where the reciprocal is contained in a fronted VP, only allows for the EA of the embedded clause *we* to act as the antecedent of the reciprocal. Why?

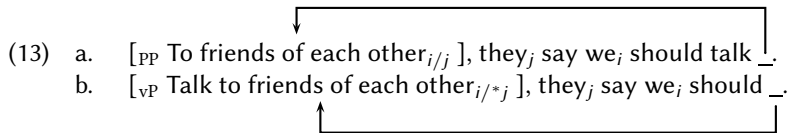

# Merge-position of the EA

## *Auxiliary assumptions:*

- The antecedent of a reciprocal can be determined at any point of the derivation: it suffices that an NP c-commands the reciprocal in *any* of the representations generated by the repeated application of (internal and external) Merge in order to count as its antecedent.
- The derivation of (13-a) involves a representation where only the EA *we* c-commands the reciprocal (14-a) (because the embedding clause and its EA *they* have not been generated yet).
- It also involves a representation where only *they* c-commands *each other* (but *we* does not) because the PP has moved to a position in between the two EAs (14-b). (This movement is undone by further movement at some subsequent step. We will come back to this.)
- The representations (14-a,b) generate the two readings of (13-a).

- (14) a.  $we_i$  should talk [<sub>PP</sub> to friends of each other<sub>*i*</sub> ]  
b.  $they_j$  say [<sub>PP</sub> to friends of each other<sub>*j*</sub> ]  $we_i$  should talk \_
- 



# Merge-position of the EA

## *The puzzle:*

- The derivation of (13-b) also involves a representation analogue to (14-b) (involving temporary movement of vP to a position in between the two EAs), see (16). Why doesn't this lead to *they* being a possible antecedent for *each other*?
- At this point, an important principle of syntactic theory comes into play, which we will talk about later in more detail: a Minimality Requirement (15) (Rizzi 1990; cf. also Fanselow 1991, Chomsky 1995).

## (15) *Minimality:*

If in a structure

$$\Sigma = \alpha \dots [\dots \beta \dots [\dots \gamma \dots] \dots]$$

(where  $\alpha$  asymmetrically c-commands  $\beta$ , and  $\beta$  c-commands  $\gamma$ )

both  $\alpha$  and  $\beta$  are of the right type to potentially establish a relation R with  $\gamma$ , then  $\gamma$  can establish R only with  $\beta$  (but not with  $\alpha$ ).

# Merge-position of the EA

*Reasoning (Huang 1993):*

- Suppose the EA *we* is first merged in Specv of the embedded clause and then moved to Spec?P. Later, the vP undergoes a first movement step, resulting in (16).
- In (16), one may expect the (unpronounced) copy  $\langle we \rangle$  in Specv (of the moved vP) to block *they* from becoming the antecedent of the reciprocal due to Minimality because this copy c-commands the reciprocal (and is asymmetrically c-commanded by *they*).
- In contrast, the PP in (14-b) does not contain a copy  $\langle we \rangle$ , hence the EA *they* can become the antecedent of *each other*.

(16) they<sub>j</sub> say [<sub>vP</sub>  $\langle we_i \rangle$  talk to friends of each other\*<sub>j</sub> ] we should \_.



*Upshot:*

Assuming that the EA is merged in Specv (and later moved to Spec?P, instead of being merged in Spec?P directly) allows, provided some further assumptions, to account for the difference between (13-a) and (13-b).

# The category T

## Observation:

If there is a modal verb, then the main verb does not inflect for tense (person, number). Rather, it shows up in its infinitival form (17-a-d).

- (17) a. \*Gilgamesh *might loved* Ishtar.  
b. Gilgamesh *might love* Ishtar.  
c. \*Gilgamesh *can loves* Ishtar.  
d. Gilgamesh *can love* Ishtar.

## Interpretation:

- The modal “absorbs” the morpho-syntactic feature [tense] ([person], [number]), leaving nothing for the verb to inflect for.
- [Tense] is located on a head outside vP. This head is called T (mnemonic for “tense”; but it is also often assumed to comprise information about person and number). I.e., ? = T in (6).
- The modal forms a projection (let us call it  $vP_{mod}$ , alongside  $vP_{cause}$ ) between TP and  $vP_{cause}$ ; the EA moves to SpecT; see (18)
- For now, let us assume that “absorption” (in the sense above) is a consequence of head-movement of the modal to T.

# The category T

(18)

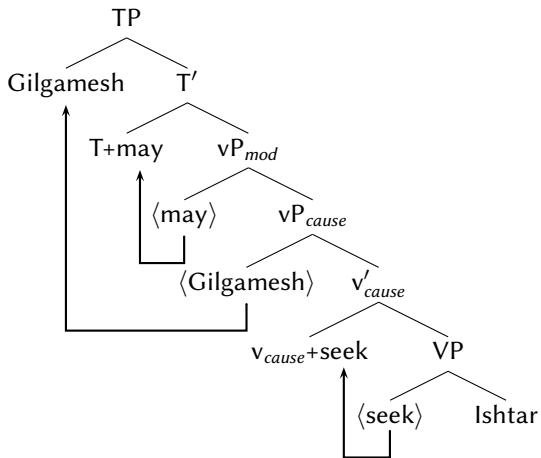

# The category T

## *VP-fronting and do-support:*

- Observation: If in the context of VP-fronting there is no modal (or other auxiliary verb, (19-a)) present, then tense (person, number) is realized on the minimal verbal auxiliary *do* (19-b,c).
- Interpretation: In VP-fronting contexts, the features present on T cannot be realized on the main verb (for some reason) and therefore *do* is inserted into T. *Do* in (19-c) indicates that the head bearing [tense] ([person], [number]), i.e., T, is merged vP-externally.

(19) a. Enkidu said he would free the animals ...

... and [*free the animals*] he *will*    .



b. Enkidu said he freed the animals ...

\*... and [*freed the animals*] he    .



c. Enkidu said he freed the animals ...

... and [*free the animals*] he *did*    .



# The category T

## *VP-ellipsis and do-support:*

- Observation: *Do*-support also shows up in contexts of VP-ellipsis in the absence of any auxiliary verb.
- Interpretation: As v+V is ellided, [tense] ([person], [number]), which is located outside vP on T, must be picked up by generating *do* in T.

- (20) a. Gilgamesh loved Ishtar . . .  
    . . . and Enkidu *did*  $\Delta$  too. ( $\Delta$  = *love Ishtar*)
- b. Gilgamesh fears death . . .  
    . . . and Shamash *does*  $\Delta$  too. ( $\Delta$  = *fear death*)

# The category T

## *Infinitival to:*

- Observation: The infinitival marker *to* in English shows up only if there is no [tense] present (21). Moreover, *to* is incompatible with the presence of a modal or *do*-support (22), (23).
- Interpretation: *to* is an instance of (non-finite) T (T without [tense]). If T = *to*, there is no *do*-insertion (with VP-ellipsis), and the modal cannot move to T (but for some reason it would need to) because T lacks [tense].

- (21) a. She tried [ to leave ].  
b. \*She tried [ to left ].

- (22) a. \*She tried [ to may leave ].  
b. \*She wanted [ to can leave ].

- (23) a. Enkidu wanted to leave . . .  
    . . . and Ishtar tried to  $\Delta$ . ( $\Delta$  = *leave*)  
b. Enkidu wanted to leave . . .  
    \* . . . and Ishtar tried to do  $\Delta$ . ( $\Delta$  = *leave*)

# Grammatical functions

## *Definition of grammatical functions:*

- The element that moves to SpecT is also referred to as the *subject*. The complement of V (an IA) is referred to as the (direct) *object*.
- This means that the notions of subject and object, in the present theory, are defined in terms of phrase structure.



# Perfective und progressive auxiliaries

## Observations:

- English exhibits perfective and progressive auxiliary verbs *have* and *be*, respectively, which show up to the right of modals and infinitival *to* (24-a,b), i.e., below TP/vP<sub>mod</sub>.
- VP-ellipsis (25-a) and VP-fronting (25-b) suggest that these auxiliaries are merged above vP.
- If they co-occur, then the perfective precedes the progressive (26).

(24) a. I *might have* eaten some seaweed.

b. I'd planned *to have* finished by now.

(25) a. Gilgamesh wanted to have finished, ...

... and Enkidu wanted to have  $\Delta$ , too. ( $\Delta$  = finished)

b. I'd planned to have finished, ...

... and [<sub>vP</sub> *finished* ] I have \_.



(26) a. Posy has been sleeping.

b. \*Posy was having slept.

# Perfective und progressive auxiliaries

(27) Posy might have been sleeping.

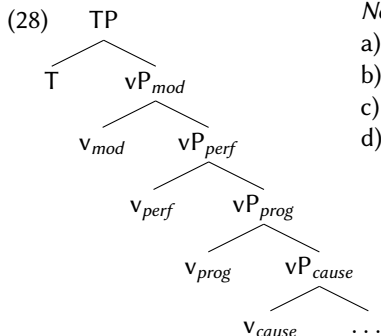

*Note:*

- a)  $v_{prog}$  selects for  $v_{cause}$
- b)  $v_{perf}$  selects for  $v_{prog}$  or  $v_{cause}$
- c)  $v_{mod}$  selects for  $v_{perf}$ ,  $v_{prog}$  or  $v_{cause}$
- d) T selects for  $v_{mod}$ ,  $v_{perf}$ ,  $v_{prog}$  or  $v_{cause}$

# Negation and head-movement

*Observations (English):*

Clausal negation shows up directly after a) the modal (if present), (29); b) the perfective (no modal present), (30); c) the progressive (no modal or perfective present), (31).

- (29)
- a. \*Gilgamesh not might have been reading the cuneiform tablets.
  - b. Gilgamesh might not have been reading the cuneiform tablets.
  - c. \*Gilgamesh might have not been reading the cuneiform tablets.
  - d. \*Gilgamesh might have been not reading the cuneiform tablets.
- (30)
- a. \*Gilgamesh not has been reading the cuneiform tablets.
  - b. Gilgamesh has not been reading the cuneiform tablets.
  - c. \*Gilgamesh has been not reading the cuneiform tablets.
- (31)
- a. \*Gilgamesh not is reading the cuneiform tablets.
  - b. Gilgamesh is not reading the cuneiform tablets.
  - c. \*Gilgamesh is reading not the cuneiform tablets.

# Negation and head-movement

## *Generalization:*

Clausal negation in English shows up directly after the highest auxiliary (including modals) that is present.

## *Analysis:*

- Suppose negation is a functional head that is merged directly below TP, that is, directly above the highest auxiliary (including modals) that is present.
- We already said that the modal moves to T. We now have the argument for this, in a generalized form: in fact, it is the highest auxiliary that is present (including modals) which moves to T.
- From this, it follows that negation always shows up directly after the highest auxiliary.
- (Aside: The most straightforward assumption is to assume that the highest auxiliary *always* moves to T in English, even if this is not detectable in the acoustic output due to the absence of negation.)

# Negation and head-movement

(32)

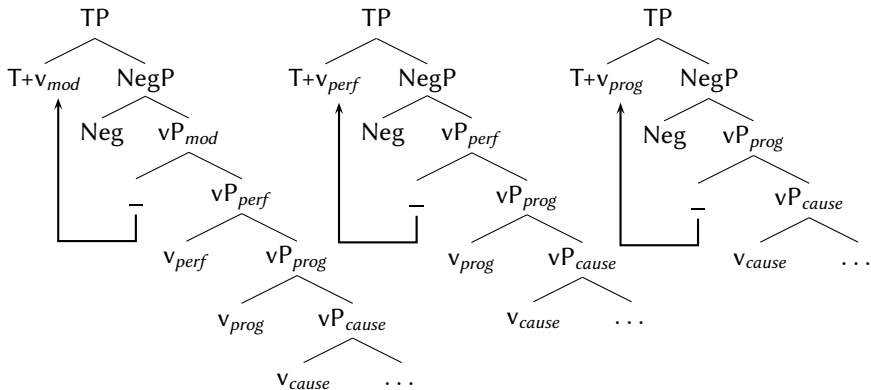

# Movement to SpecT generalized

*Movement of the EA:*

- So far: The EA is merged in Specv (realizing the agent-role) and then moves to SpecT.
- Usually, if there are several arguments present (as in a transitive, (33)), it is the EA that moves to SpecT, (33), and not, e.g., the IA. (This actually reminds Minimality in (15), but it is not *quite* the same; why?)

(33)

a.

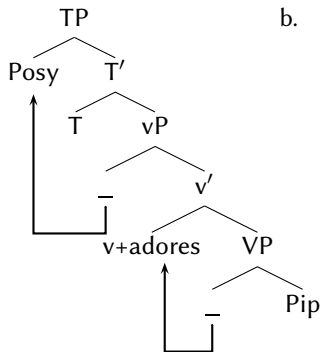

b.

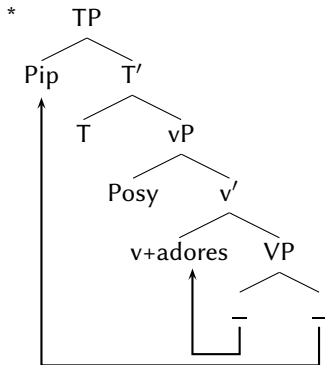

# Movement to SpecT generalized

*Movement of the IA:*

- But this is not always the case. In particular, if no EA is present, then some other argument has to move to SpecT.
- This is illustrated in (34) by the case of an unaccusative, where the IA moves to SpecT.

(34)

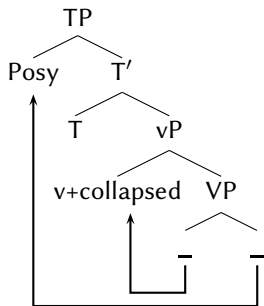

# Movement to SpecT generalized

## *Interpretation:*

- There is a general requirement in English that TP has a specifier that is to be filled by an argument.
- This implies that movement to SpecT also takes place when it would apply string vacuously, i.e., when it is not detectable in the acoustic signal, as for instance with movement of the EA in the absence of any auxiliary/modal (as in (33-a)).



# Negation and main verbs

## *Note:*

- Main verbs in English do not move to T, in contrast to modals and auxiliaries.
- This is obvious from the fact that they do not show up to the left of clausal negation, even not in the absence of modals/auxiliaries (35).
- Therefore, movement of the EA to SpecT only becomes visible in the presence of a modal or an auxiliary.

(35) \*Gilgamesh flew not the broomstick.

## *Aside:*

If there is negation, the main verb cannot simply remain in its base position either (36-b). Rather, *do*-support has to apply (36-a) (see Chomsky 1991, Bobaljik 1994, Grimshaw 1997 for analyses).

- (36) a. Gilgamesh didn't fly the boomstick.  
b. \*Gilgamesh not flew the broomstick.

# Some cross-linguistic variation

## French:

- Main verbs in French move to T, alongside auxiliary verbs (37-a,b). (Background assumption: the head of clausal negation in French is marked by *pas*, not by *ne*.)
- In fact, they must move to T (38).

(37) a. Jean n'aime pas          Marie.  
Jean NE=loves not Marie  
'Jean doesn't love Marie.'

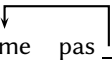

b. Jean n'a pas          aimé Marie.  
Jean NE=has not loved Marie  
'Jean hasn't loved Marie.'

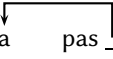

(38) a. \*Jean (ne) pas aime Marie.  
b. \*Jean (ne) pas a aimé Marie.

# Some cross-linguistic variation

## *Mainland Scandinavian:*

In mainland Scandinavian (here: Swedish) neither main verbs nor auxiliaries move to T (39-a,b), (40-a,b).

- (39) a. om hon inte har köpt boken  
whether she not has bought book.the  
'whether she has not bought the book'
- b. om hon inte köpte boken  
whether she not bought book.the  
'whether she did not buy the book'

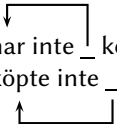
- (40) a. \*om hon har inte \_ köpt boken  
b. \*om hon köpte inte \_ boken
- 

## *Aside:*

Insular Scandinavian (Icelandic, Faroese) is more like French in this respect.

# Some cross-linguistic variation

*Scottish Gaelic (Adger 2003):*

- Celtic languages exhibit VSO-word order. This can be analyzed by assuming that these languages have verb movement to T (including main verbs) but lack argument movement to SpecT. (41) illustrates for Scottish Gaelic.
- The analysis predicts that in VP-ellipsis only the verb remains audible. This is correct (42-a,b).

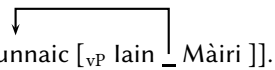
(41)   
[<sub>TP</sub> ChunnaiC [<sub>VP</sub> Iain          Màiri ]].  
see.PAST Iain Màiri  
'Iain saw Màiri.'

(42) Am faca tu Màiri?  
Q see.PAST you Mary  
'Did you see Mary?'

- a. ChunnaiC Δ.  
see.PAST  
'Yes' (Δ = I Mary)
- b. Chan fhaca Δ.  
Neg see.PAST  
'No' (Δ = I Mary)

# Some cross-linguistic variation

*German:*

Due to its verbal head-finality in embedded clauses (and other factors), it is hard to determine whether German exhibits movement to T or SpecT. In both cases, such movement would (often) apply string vacuously:

(43) a.

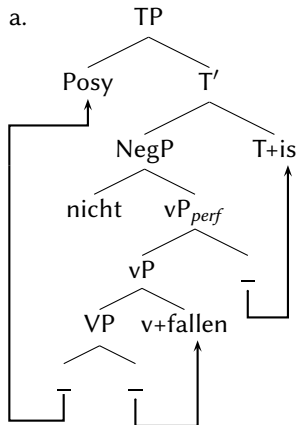

b. dass Posy (nicht) gefallen ist  
that Posy (not) fallen is  
'that Posy did not fall'

# Bibliography I

- Adger, D. (2003). *Core Syntax*. Oxford University Press, Oxford.
- Bobaljik, J. (1994). What does adjacency do? In Harley, H. and Phillips, C., editors, *The Morphology-Syntax Connection: MIT Working Papers in Linguistics 22*, pages 1–32. MIT Press, Cambridge, Massachusetts.
- Chomsky, N. (1991). Some notes on economy of derivation and representation. In Freidin, R., editor, *Principles and Parameters in Generative Grammar*, pages 417–454. MIT Press, Cambridge, Massachusetts.
- Chomsky, N. (1995). *The Minimalist Program*. MIT Press, Cambridge, Massachusetts.
- Fanselow, G. (1991). *Minimale Syntax*. Habilitation, Universität Passau.
- Grewendorf, G. (2002). *Minimalistische Syntax*. A. Francke Verlag, Tübingen.
- Grimshaw, J. (1997). Projection, heads, and optimality. *Linguistic Inquiry*, 28:373–422.
- Huang, C.-T. J. (1993). Reconstruction and the structure of VP: Some theoretical consequences. *Linguistic Inquiry*, 24:103–138.

## Bibliography II

Rizzi, L. (1990). *Relativized Minimality*. MIT Press, Cambridge, Massachusetts.

Sportiche, D. (1988). A theory of floating quantifiers and its corollaries for constituent structure. *Linguistic Inquiry*, 19:425–449.